

# EnOcean to BACnet MS/TP Gateway

EO-BAC

User Manual V1.5

English

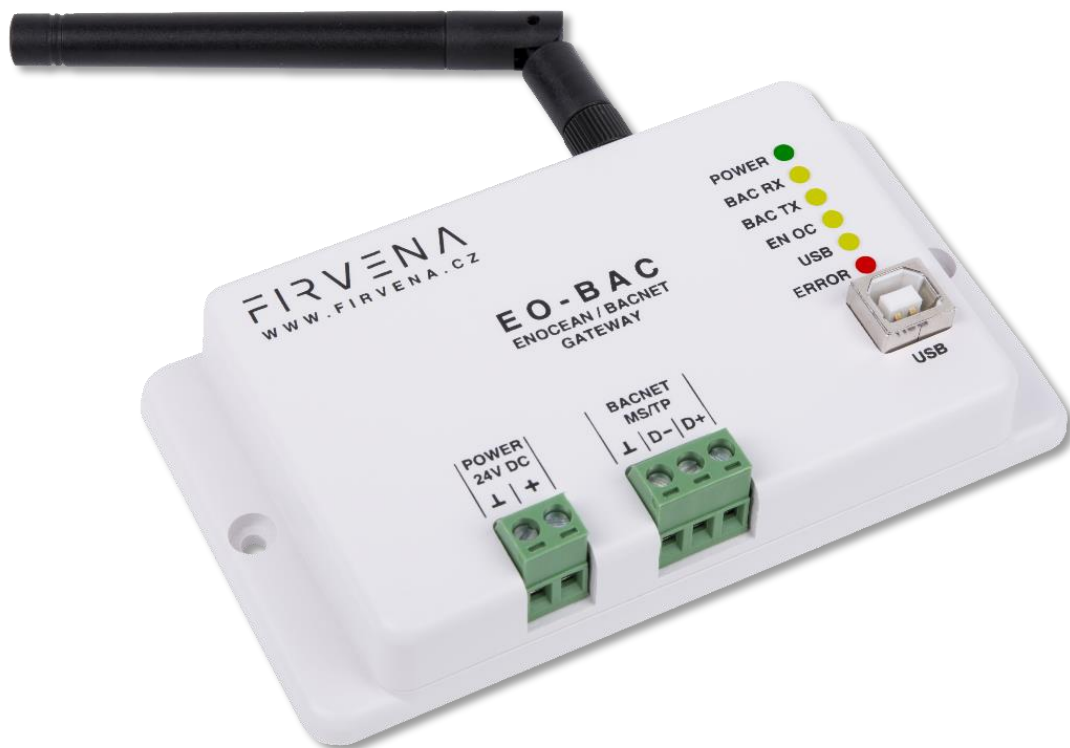

## Contents

Contents .....	2
Terms and Abbreviations .....	4
List of Figures and Tables .....	5
1 Introduction.....	6
2 Hardware Overview.....	7
3 Technical Data .....	9
4 Safety Information and Warnings .....	11
5 Power Supply.....	12
6 Configuration.....	13
6.1 EO-BAC Tool.....	13
6.1.1 Main window overview .....	13
6.1.2 Assigning EnOcean elements – unidirectional .....	14
6.1.3 Assigning EnOcean elements – bidirectional .....	15
6.1.4 Assigning Smart ACK devices.....	16
6.1.5 Definition of Virtual Device .....	16
6.1.6 Removing EnOcean elements.....	17
6.1.7 Backup and Restore.....	17
7 BACnet Interface .....	19
7.1 Mapping of EnOcean Devices.....	19
7.2 Supported Object Types .....	22
7.2.1 Device .....	22
7.2.2 Analog Input (AI).....	23
7.2.3 Analog Output (AO).....	23
7.2.4 Multistate Value (MSV) .....	24
7.3 Proprietary properties.....	26
7.4 COV Notifications .....	26
8 Firmware Update.....	28
References.....	29
Revision History.....	30
ANNEX A Mapping examples of EnOcean devices .....	31
A.1 Basic Examples .....	31
A.2 RPS Buttons and Switches .....	33

---

A.3	A5-20-01 HVAC Components, Battery Powered Actuator .....	33
A.4	D2-01-XX Electronic switches and dimmers with Energy Measurement and Local Control.	34
A.4.1	Example with NodOn Micro Smart Plug (D2-01-0E) – Measurements .....	34
A.4.2	Example with NodOn Relay Switch (D2-01-12) – Controlling the output .....	36
A.5	D2-11-XX Bidirectional Room Operating Panel (Smart ACK).....	37
A.5.1	Example with Thermokon SR06 LCD (D2-11-07) .....	37
A.6	D2-15-00 People Activity Sensor .....	39
ANNEX B	BACnet Protocol Implementation Conformance Statement (PICS) .....	40

## Terms and Abbreviations

<b>Term/Abbr.</b>	<b>Explanation</b>
Channel number (CH) .....	Identifier of EnOcean device within the gateway
COV .....	Change of Value
DHCP .....	Dynamic Host Configuration Protocol
EEP .....	EnOcean Equipment Profiles
EURID .....	EnOcean Unique Radio Identifier
Label .....	User-friendly name of EnOcean device
IP .....	Internet Protocol
PoE .....	Power over Ethernet
MS/TP .....	Master-Slave/Token Passing (data link layer protocol)
RX .....	Receive, reception
Teach-in .....	Pairing of EnOcean devices
Telegram .....	EnOcean message
TX .....	Transmit, transmission
UCOV .....	Unsubscribed COV
UPnP .....	Universal Plug and Play
Value index .....	Identifier of a data unit within the channel

## List of Figures and Tables

### Figures

Fig. 1.1 Functional overview.....	6
Fig. 2.1 Gateway overview – front side .....	7
Fig. 2.2 Gateway overview – meaning of manual switches .....	7
Fig. 5.1 Power supply via POWER connector .....	12
Fig. 6.1 Main window overview.....	13
Fig. 6.2 Adding elements – teach-in procedure .....	14
Fig. 6.3 Adding elements – manually .....	15
Fig. 6.4 Adding elements – bidirectional teach-in procedure .....	16
Fig. 6.5 Adding elements – virtual device.....	17
Fig. 6.6 Virtual device – send teach-in telegram .....	17
Fig. 7.1 Conversion of data .....	19
Fig. 7.2 Values.....	20
Fig. 7.3 Mapping of EnOcean devices.....	21
Fig. 7.4 Numbering of objects .....	21
Fig. 7.5 Repeater function .....	25

### Tables

Tab. 2.1 LED functions.....	8
Tab. 3.1 Technical data.....	9
Tab. 7.1 Helper values .....	20
Tab. 7.2 Device object – properties.....	22
Tab. 7.3 Analog input object – properties.....	23
Tab. 7.4 Analog output object – properties .....	23
Tab. 7.5 Multistate value object – properties.....	24
Tab. 7.6 List of MSV objects .....	25
Tab. 7.7 Proprietary properties.....	26

## 1 Introduction

The EO-BAC device is a gateway between EnOcean and BACnet MS/TP communication protocols (Fig. 1.1). EnOcean and BACnet are a set of technologies and communication protocols that are widely used in building automation systems. The EnOcean is a technology that enables the use of wireless and batteryless sensors, switches and actuators. The BACnet is a communication protocol that was designed to provide unified interface for data exchange across a building management system. The EO-BAC gateway can receive data from up to 40 EnOcean devices, store it and provide it through the BACnet MS/TP interface to other devices connected to the BACnet network.

The first part of this manual describes the hardware of the gateway. Chapter 6 describes the BACnet interface and explains how EnOcean devices are mapped to BACnet objects. Chapter 7.3 contains brief instructions for configuring the gateway, especially for connecting EnOcean devices. For firmware update procedure refer to Chapter 7.4.

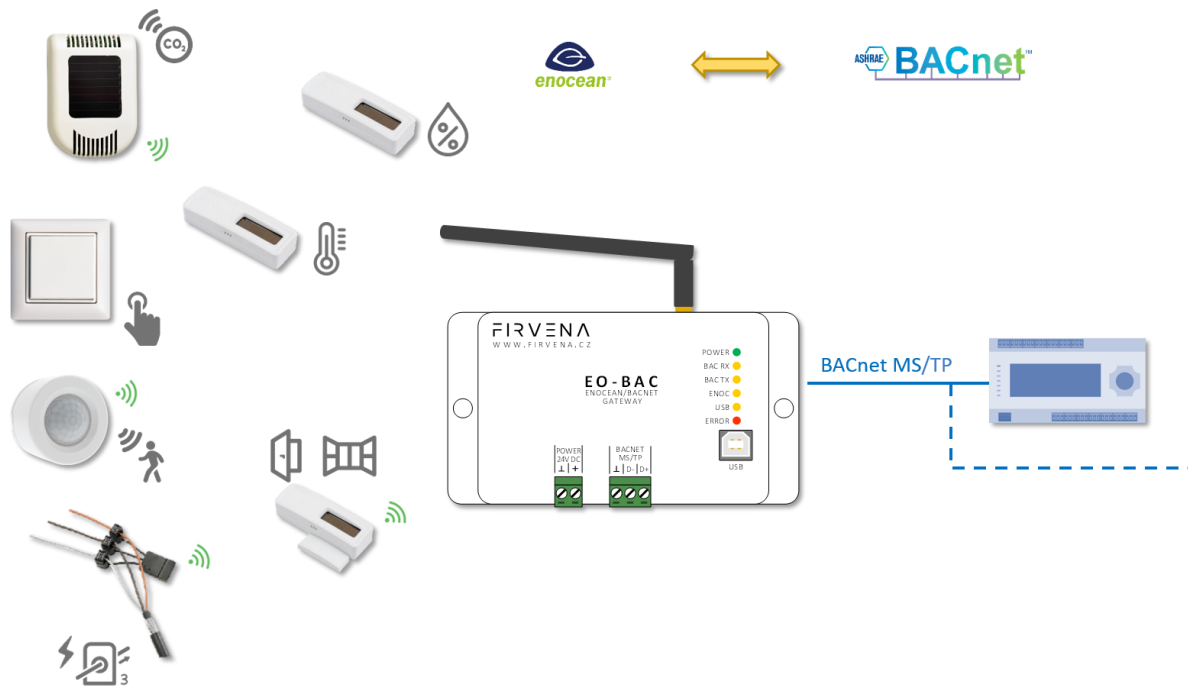

Fig. 1.1 Functional overview

## 2 Hardware Overview

There is a power connector, RS-485 connector, type B USB connector, antenna connector and LED indicators on the front panel (Fig. 2.1). The USB connector is used for configuration and firmware update, it is used by the *EO-BAC Tool* configuration application. The green POWER and RS-485 connectors are removable, which simplifies device handling if wires are connected.

The LEDs indicates the connection of power supply (POWER), traffic in the BACnet network (BAC RX, BAC TX), traffic in the EnOcean wireless network (ENOC), communication through the USB interface (USB) and error states (ERROR). The LEDs are useful when testing or commissioning but the light can be disruptive in normal operation, for that reason, the LEDs can be disabled (EO-BAC Tool > Gateway Settings > LED Indication). See Tab. 2.1 for the meaning of individual indicators.

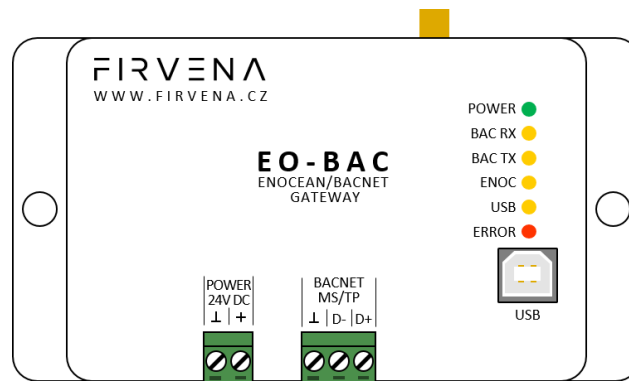

Fig. 2.1 Gateway overview – front side

There are two switches beside the RS-485 connector that are accessible after pulling out the RS-485 connector (Fig. 2.2).

The left switch sets the USB interface mode:

- the **“HID” position (default)** allows the *EO-BAC Tool* application to be connected
- the **“MSC” position** activates the firmware update mode (see Ch. 7.4)

The right switch connects a 120-ohm termination resistor to the RS-485 line:

- **“OFF” (default)**: termination resistor disconnected
- **“ON”**: connected

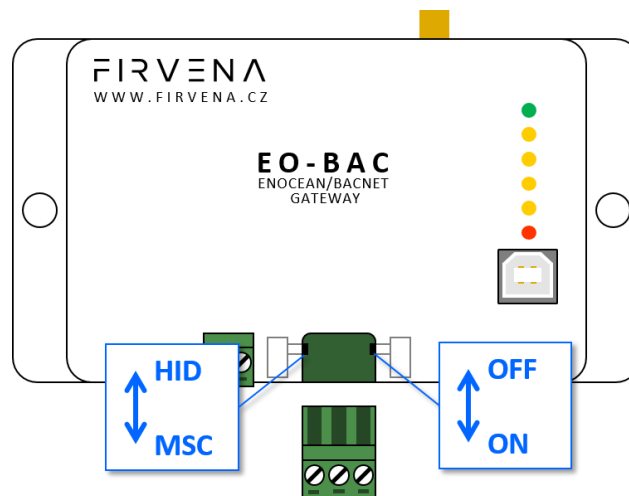







Fig. 2.2 Gateway overview – meaning of manual switches

Tab. 2.1 LED functions

Case	LEDs	Behavior	Meaning
Power supply	POWER 	Shining	Power supply connected and program running
BACnet communication	BAC RX 	Short blink	Traffic in the BACnet network – received a packet
	BAC TX 	Short blink	Traffic in the BACnet network – sent a packet
EnOcean	ENOC 	Short blink	EnOcean telegram received or sent
USB	USB 	Flashing irregularly	Indicates communication through the USB port
–	ERROR 	Flashing regularly	A fatal error has occurred, the device is about to restart



### 3 Technical Data

Tab. 3.1 Technical data

Category	Parameter	Value
Product	Product name	EO-BAC
	Product title	EnOcean to BACnet MS/TP Gateway
	Product ID	7.1
	Vendor name	FIRVENA s.r.o.
Electrical data	Rated supply voltage	24 V DC
	Supply voltage range	10–32 V DC
	Rated input current	50 mA
	Rated input power	1.2 W
RS485 (BACnet MS/TP)	Baud rate	9.6, 19.2, 38.4, 57.6, 76.8 or 115.2 kBd
	Data bits	8
	Stopbits	1
	Parity	none
	Maximum number of devices on the line	32
	Termination	Manually activated 120 Ω resistor
EnOcean	Frequency	868 MHz
	Maximum number of handled devices	40 (max. 20 with SmartACK)
	Repeater	✓
USB	Device class	Custom HID or Mass Storage
	Connector	Type B
Operating conditions	IP Code	IP20
	Operating temperature	–20 to +70 °C
	Relative humidity	max. 80 %
Dimensions in mm	Dimensions without antenna	Width=126, Height=71, Depth=25
Weight	Weight without antenna	115 g
Box material		ABS, white
EMC	In accordance with the directive	2014/53/EU, 2011/65/EU RoHS
EMC	Approvals tests	ČSN EN 55032, ČSN EN 55035, ČSN EN 6100-4-2, ČSN EN 6100-4-3, ČSN EN 6100-4-4, ČSN EN 6100-4-5, ČSN EN 6100-4-6, ČSN EN 6100-4-11, ČSN EN IEC 6100-6-2

Dimensions in mm:

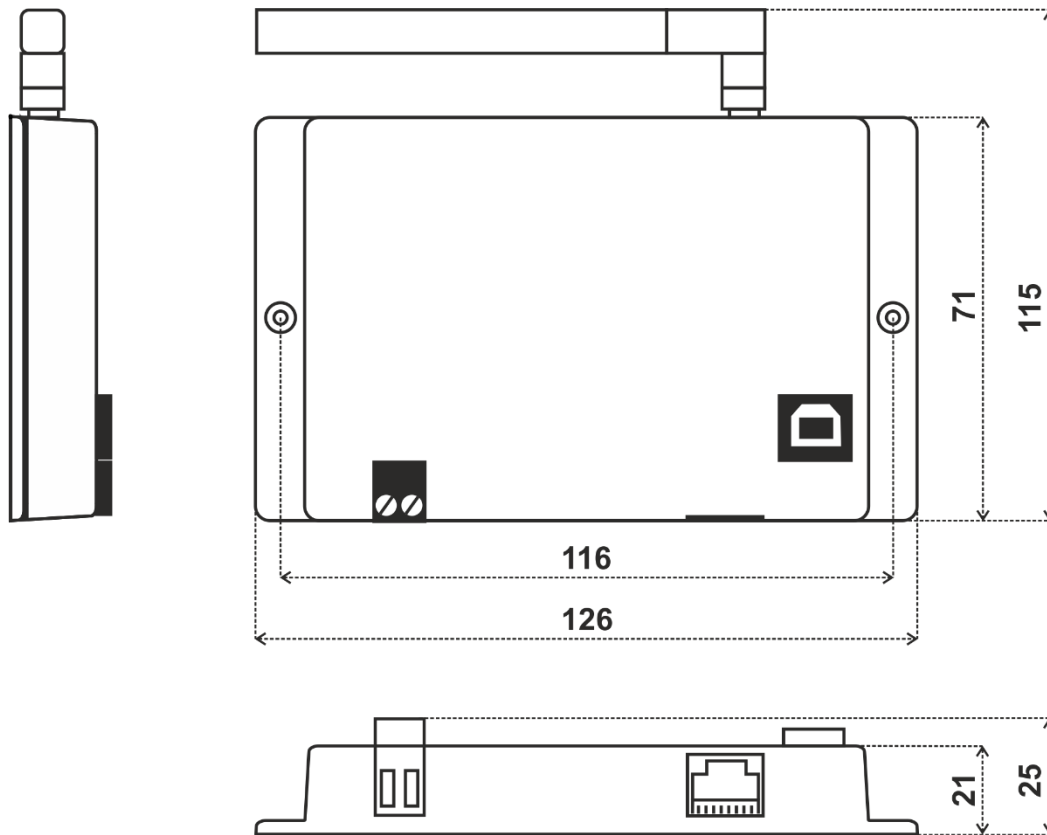

## 4 Safety Information and Warnings



Please follow the general safety requirements. This equipment may only be installed by a qualified person (accredited electrician) and after reading these instructions. Improper installation may cause damage to health, property or the equipment itself.

The product meets the general safety requirements. Cover IP 20 allows installation only in normal space.

The gateway must be powered from a safe voltage source that meets the requirements for input voltage range and must be installed in accordance with national and safety standards.

The product may only be used in accordance with this manual.

To avoid a risk of an electrical shock or fire, the maximum of gateway's operating parameters must not be exceeded.

Use only unmodified products.

It can be used types of cables with sufficient electrical strength for connection.

### Storage

Store products at temperature 0-40 °C and relative humidity up to 80 %, and in spaces where condensation on products is eliminated. Products must not be exposed shocks, harmful vapors or gases.

### Repairs

Products are repaired by the manufacturer. Products to be repaired are shipped in a package that ensures shock absorption and protects the products against damage during shipment.

### Guarantee

The product is warranted 24 months from the date of delivery that is mentioned on the delivery note. The manufacturer guarantees technical and operational products parameters in the range of valid documentation. The warranty period runs from personal goods acceptance by the buyer or from the transport company. Claimed products and written claims for defects are claimed by the manufacturer during warranty period. The complainant shall provide products identification, number of delivery note and defects description. The manufacturer is not responsible for defects caused by improper storage, improper external connection, damages caused by external influences especially due to unacceptable size, incorrect adjustment, improper installation, incorrect operation or normal wear and tear.

### Product disposal



The product does not belong to municipal waste. The product must be disposed to the separate waste collection with the possibility of recycling, according to local regulations and legislation. The product contains electronic components.

### ROHS Directive



The device is manufactured in accordance with the directive 2015/863/EU (RoHS 3) of the European Parliament and of the Council on the restriction of the use of certain hazardous substances in electrical and electronic equipment.

## 5 Power Supply

### Power supply from an external source:

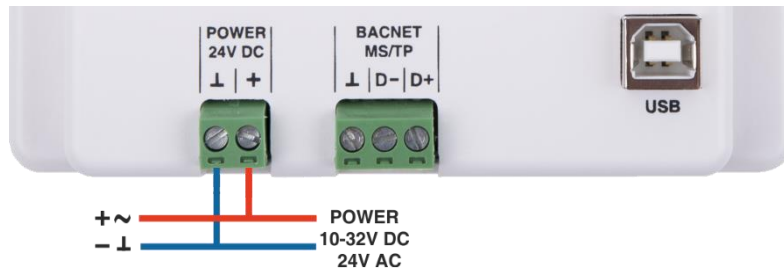

Fig. 5.1 Power supply via POWER connector

The gateway must be powered from a safe voltage source that meets the requirements for input voltage range. The electrical installation must be in accordance with national requirements and safety standards.

## 6 Configuration

### 6.1 EO-BAC Tool

This chapter is a brief guide to the use of the *EO-BAC Tool* application.

The application *EO-BAC Tool* is used to configure the gateway. The main purpose of the application is to manage EnOcean devices connected to the gateway. The application is also a useful verification tool whereby you can evaluate whether your system works well. It allows to see the states, measured quantities, communication intervals or signal strength of the connected EnOcean devices. The application also allows setting BACnet configuration parameters such as MSTP address, baud rate, etc.

Communication between the application and the gateway is via USB interface. There is no need to install a driver, just connect the gateway to your computer using an appropriate USB cable and run the application. The application automatically connects to the first detected gateway.

#### 6.1.1 Main window overview

1. Communication control – basic control of communication with the gateway.
2. Application status – shows the state that the application is currently in.
3. Gateway – an editor of gateway configuration.
4. Teach-in telegram – the last teach-in telegram received by the connected gateway.
5. Channel configuration – an editor of the selected Rx channel.

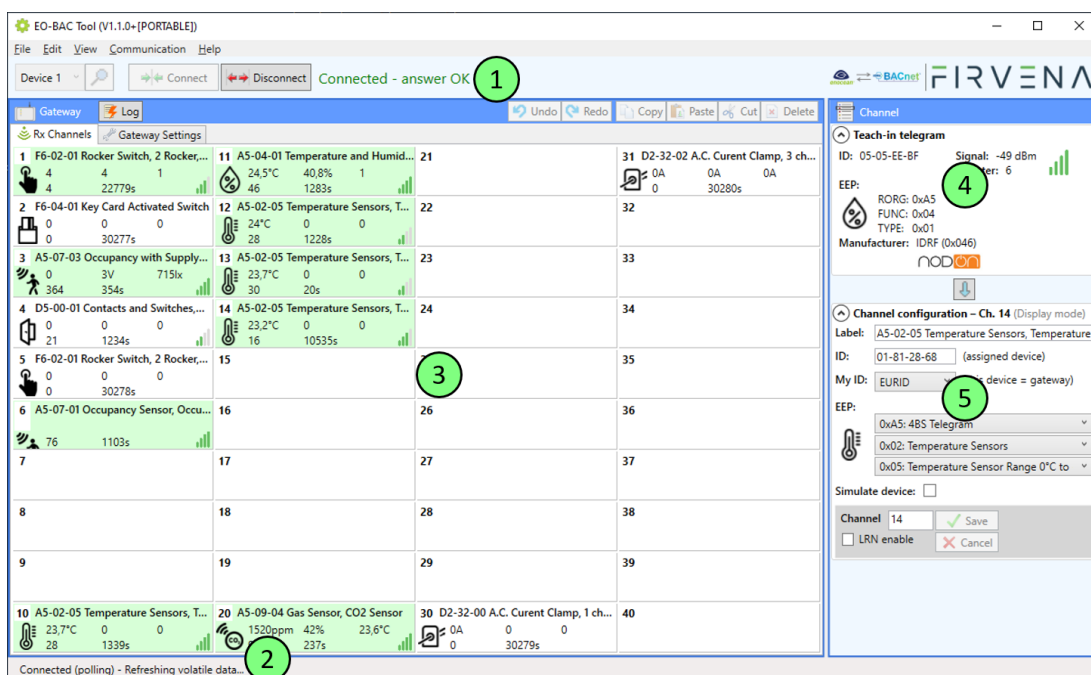

Fig. 6.1 Main window overview

### 6.1.2 Assigning EnOcean elements – unidirectional

This teach-in procedure is only applicable for unidirectional communication when the gateway only receives data.

Let's have a CO2 sensor (A5-09-04) we want to assign to the channel 35. The procedure is as follows (see Fig. 6.2):

1. Push the pairing button to transmit a teach-in telegram.
2. The received telegram is displayed in the "Channel" panel.
3. Select the channel number 35.
4. Click "Save" to confirm changes.
5. Now the sensor is assigned to channel 35 and its data is available through the BACNet interface.

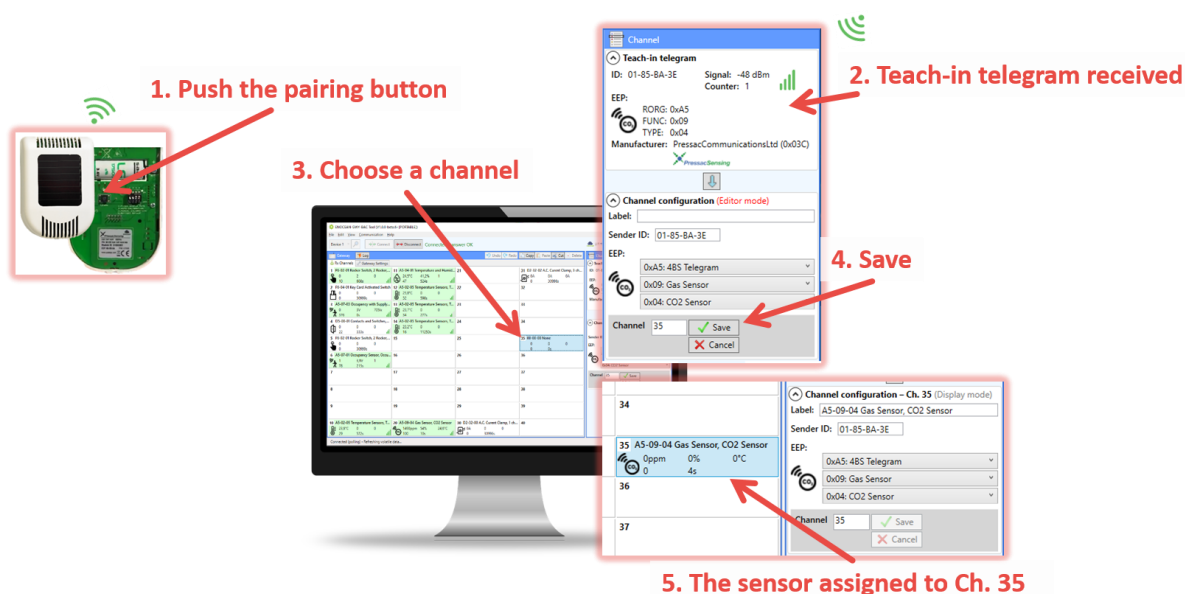

Fig. 6.2 Adding elements – teach-in procedure

Optionally, the *Label* can be set for the device. The *Label* is used in the *Description* property of the objects MSV 199–4099. If the *Label* field is left empty, the default text will be used.

The knowledge of EEP allows the gateway to interpret the received data correctly. Some types of EnOcean devices do not provide the EEP information in their teach-in telegram or even not have a special telegram for teach-in (e.g. buttons and switches). In that case, the EEP must be set manually, it is usually given by a label on the device or a datasheet.

Devices can also be assigned manually by entering the ID and EEP – Fig. 6.3.

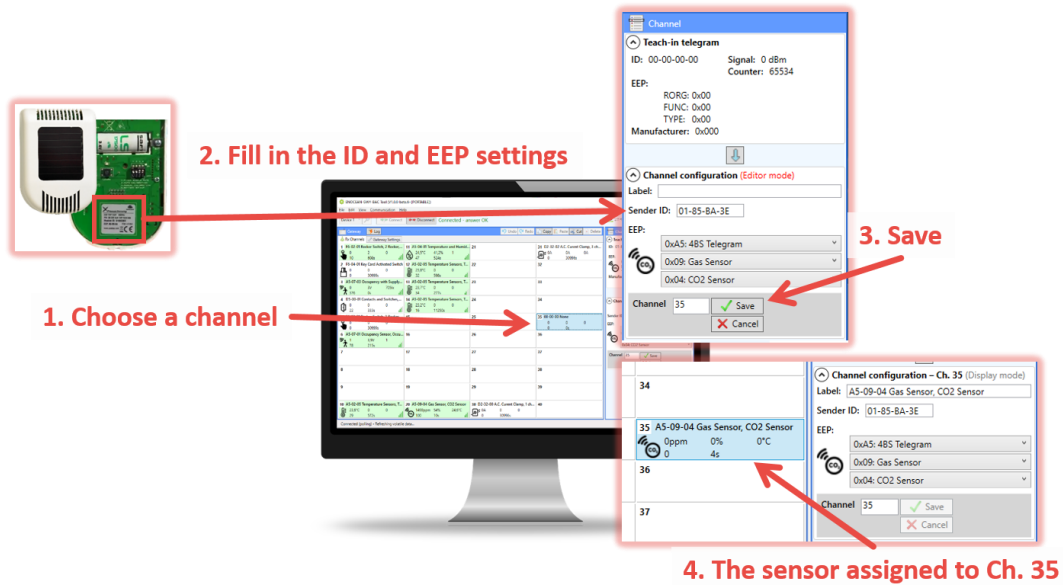

Fig. 6.3 Adding elements – manually

### 6.1.3 Assigning EnOcean elements – bidirectional

This teach-in procedure is applicable for EnOcean devices with bidirectional communication profiles when the gateway is supposed to receive data from the device and also transmit data to the assigned device.

Let's have a valve actuator (A5-20-01) we want to assign to the channel 35. The procedure is as follows (see Fig. 6.4):

1. Select the channel number 35.
2. Check the "LRN enable"

Channel 35 is now in the teach-in mode.

3. Push the pairing button to transmit a teach-in telegram from the actuator.
4. Gateway receives the telegram and sends a teach-in response.
5. The device is automatically saved to the selected channel and its data is available through the BACNet interface.

To change the Label, enter the new text and click "Save".

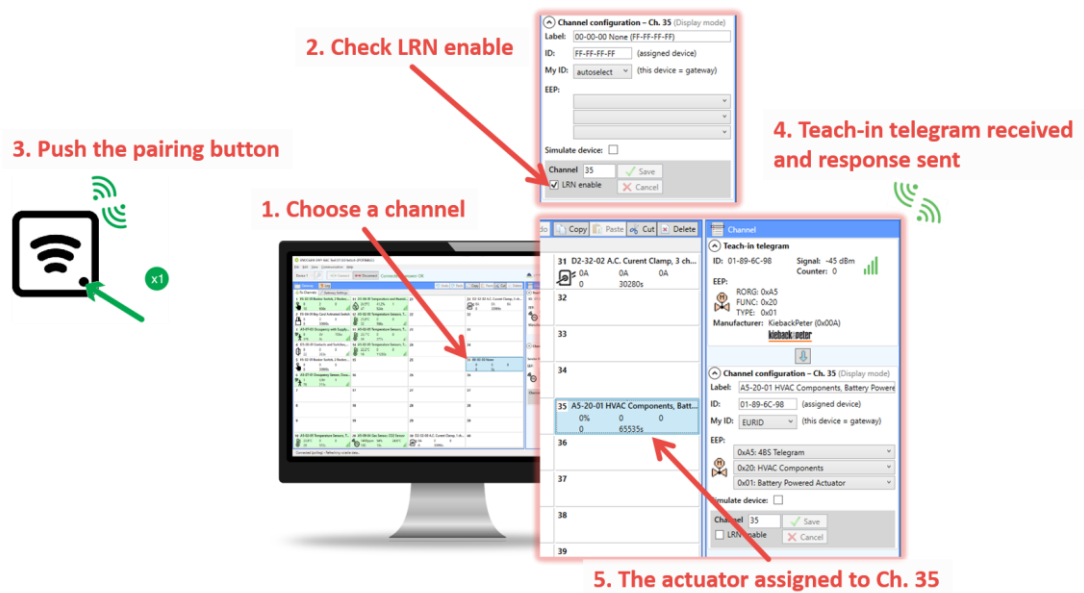

Fig. 6.4 Adding elements – bidirectional teach-in procedure

### 6.1.4 Assigning Smart ACK devices

To assign a Smart ACK device to the gateway, the procedure is the same as for bidirectional profiles (6.1.3). Repeaters are not supported, there must be a direct connection between the gateway and the Smart ACK device.

### 6.1.5 Definition of Virtual Device

The gateway can be used to simulate a real EnOcean device. This function is necessary when controlling actuators that do not implement any bidirectional profile, typically some types of relay switches.

For example, we want to control a relay switch that supports reception of a Door/Window Contact D5-00-01. The procedure is as follows.

First, define a virtual device of type D5-00-01, for example at channel 35 (see Fig. 6.5):

1. Select a channel (channel 35)
2. Check “Simulate device”
3. Select the type of device (D5-00-01)
4. Click “Save” to confirm changes
5. The device is saved to the selected channel and its data is available through the BACnet interface.

Second, pair the virtual device with the relay switch:

1. Select the channel 35 (Fig. 6.6)
2. Put the relay switch to the pairing mode (follow the procedure given by the manufacturer of the switch)
3. Click on the “Send LRN” button
4. The gateway will transmit a teach-in telegram of the virtual device
5. The switch will receive the teach-in telegram and save the virtual device

**Notes:**

- Each virtual device must have a unique ID, this is given by the MyID setting.



- To enable receiving the actual state of the switch, assign it to a different channel.

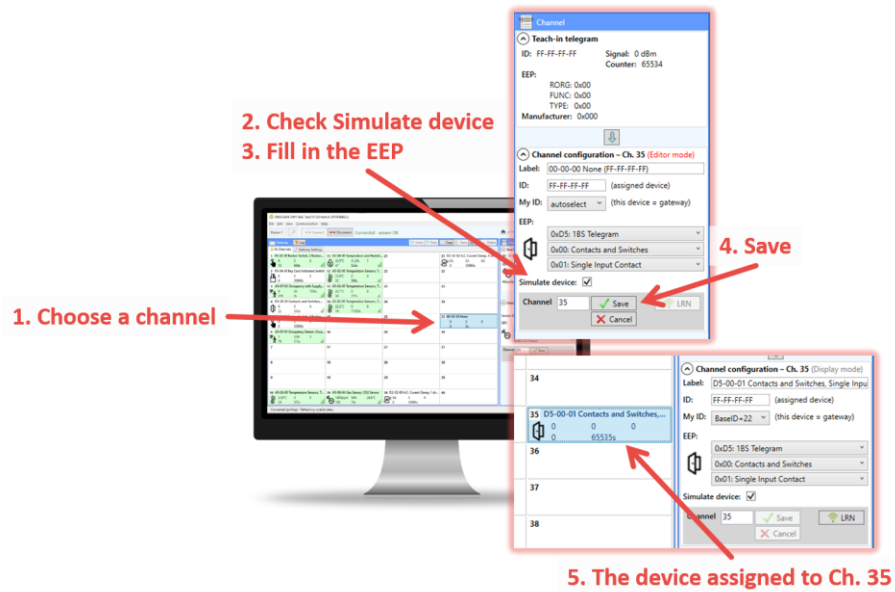

Fig. 6.5 Adding elements – virtual device

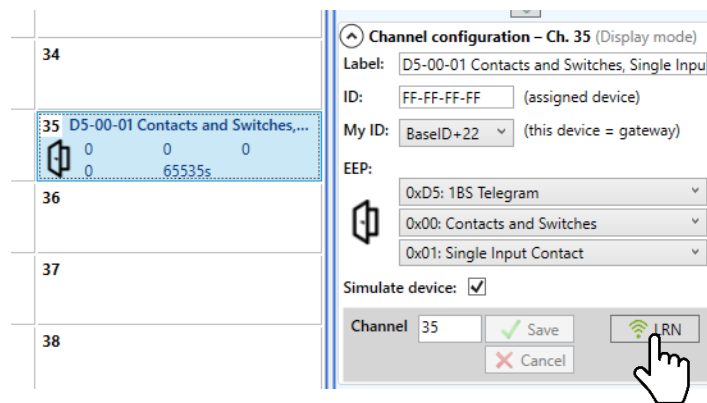

Fig. 6.6 Virtual device – send teach-in telegram

### 6.1.6 Removing EnOcean elements

- Select a channel
- Click the “Delete” button or press the Delete key

To remove all elements, select all channels (Ctrl+A) and use Delete.

### 6.1.7 Backup and Restore

The configuration of the gateway can be exported to a file for later recovery or reuse.

To back up the configuration:

- Connect the gateway and let the configuration to be loaded.
- Use the Save command [Ctrl+S] or [File > Save].
- Define the file path and name in the dialog shown.
- Confirm “Save”.

To restore the configuration:

- Connect the gateway and check if the communication works properly.

2. Use the Open command [Ctrl+O] or [File > Open].
3. Select a file and confirm “Open” in the dialog shown.
4. A prompt dialog appears, select “Yes” to confirm the gateway configuration is to be overwritten.

**Notes:**

- *If you select “No”, the file opens in a new window where you can edit it or copy individual channels to the connected gateway.*
- *Only channels are restored, the “Gateway Settings” are preserved.*

## 7 BACnet Interface

### 7.1 Mapping of EnOcean Devices

EnOcean devices are mapped as a set of standard BACnet objects. The gateway can handle up to 40 EnOcean devices. To assign an EnOcean device, the teach-in procedure has to be carried out (see Ch. 6.1). The assigned EnOcean devices are identified by *Channel* (CH1...40) within the gateway, the *Channel* is selected by user during teach-in procedure.

Data fields received in a telegram are divided into individual standard BACnet objects so that they can be accessed from the BACnet network – see Fig. 7.1. The gateway contains a database of supported EnOcean products, objects are created depending on the type of EnOcean device (EEP) that is assigned to the channel during teach-in procedure.

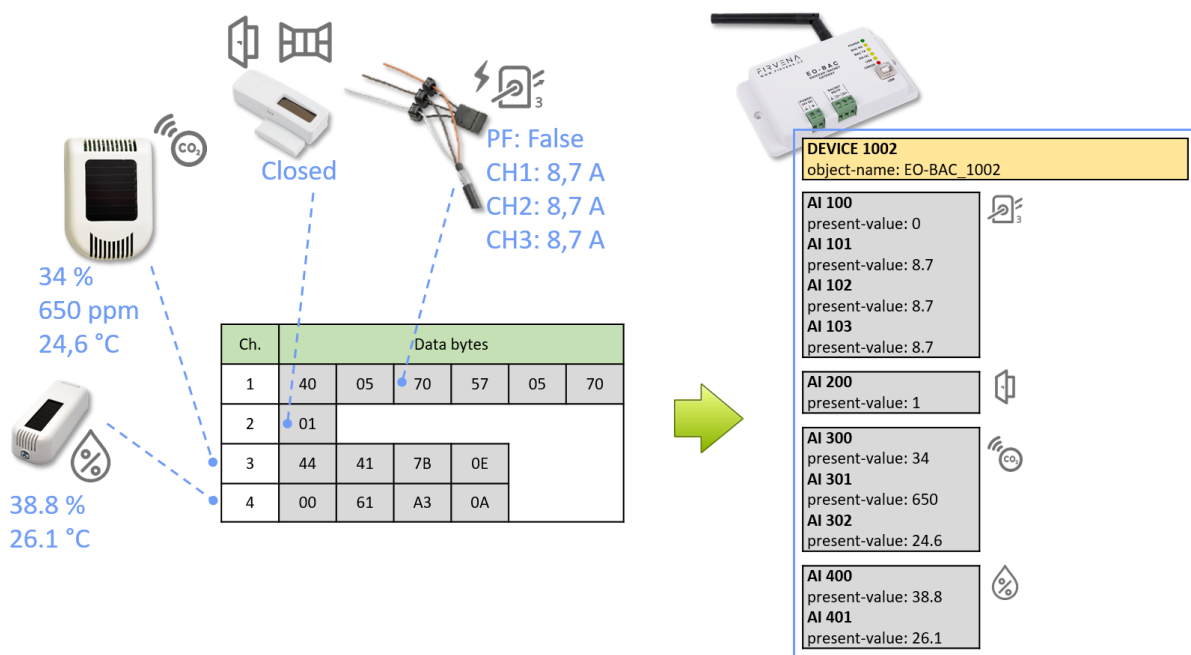

Fig. 7.1 Conversion of data

Three types of data fields are distinguished:

- **Numeric value:** usually a measured physical quantity such as temperature, humidity, etc.
- **Enumeration:** defined as a list of items that express a state or configuration of the device
- **Boolean:** two-state enumeration whose items can be interpreted as true/false, such as on/off, enabled/disabled, open/closed, etc.

In addition, two directions are distinguished:

- **RX:** data received by the gateway (incoming telegrams)
- **TX:** data transmitted by the gateway (outgoing telegrams)

The data fields are stored internally as *Values*. The *Values* are identified by *Value index*, 100 *Values* is reserved per channel (indexes 0 to 99) – see Fig. 7.2 and Fig. 7.3.

The *Values* from *Telegram data* range represent a model of EnOcean telegram. For simple devices (such as sensors with unidirectional communication) the model of telegram can also be assumed to be a model of EnOcean device. Some more complex EEP definitions consist of several types of telegrams

that represent different commands, so the device cannot be described by a single telegram. Special mapping is created for these devices.

For direction “RX”, all used *Values* are mapped to *Analog Input (AI)* objects. For direction “TX” all used *Values* are mapped to *Analog output (AO)* objects.

The mapped data fields from EnOcean telegram are indexed in the same order as they appear in the EEP definition – see [3].

Besides the data values, there are also helper values for each channel that provide status information – see Tab. 7.1. If the channel is not occupied the associated BACnet objects are hidden.

Tab. 7.1 Helper values

Index	Name	Meaning	Value Range
90	Telegram counter	Number of received/sent telegrams	0...65535 (overflows to zero)
91	Telegram age	Time elapsed since the last telegram	0...65000 s (65535: no telegram, 65001: range exceeded)

The object *Instance\_Number* (part of *Object\_Identifier* property) is composed of the *Channel number* and *Value index*. Hundreds contain the *Channel number* of EnOcean device (Channel 1...40) that the BACnet object belongs to. Units contain the *Value index* that identifies a data field (Value 0...99) – see Fig. 7.4.

Examples of mapping for individual EnOcean devices can be found in ANNEX A.

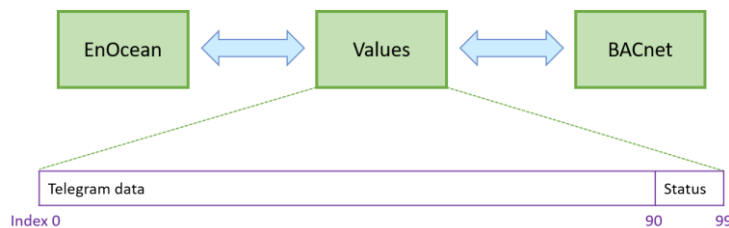

Fig. 7.2 Values



		AI		
CH1	Value 0	100	Temperature	A5-02-05 Temperature Sensors, Temperature Sensor Range 0°C to +40°C 
	Value 1	101		
	Value 2	102		
	Value 3	103		
	Value 4	104		
	...	...	...	
	Value 90	190	T. Counter	
	Value 91	191	T. Age	
CH2	Value 0	200	Humidity	A5-09-04 Gas Sensor, CO2 Sensor 
	Value 1	201	Concentration	
	Value 2	202	Temperature	
	Value 3	203	H-Sensor	
	Value 4	204	T-Sensor	
	...	...	...	
	Value 90	290	T. Counter	
	Value 91	291	T. Age	
...				
CH40	Value 0	4000	Power Fail	D2-32-02 A.C. Current Clamp, 3 channels 
	Value 1	4001	Divisor	
	Value 2	4002	Channel 1	
	Value 3	4003	Channel 2	
	Value 4	4004	Channel 3	
	...	...	...	
	Value 90	4090	T. Counter	
	Value 91	4091	T. Age	

Fig. 7.3 Mapping of EnOcean devices

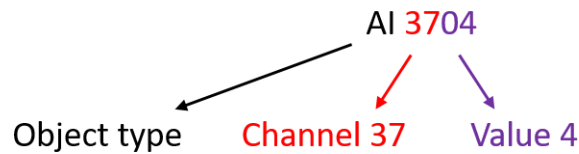

Fig. 7.4 Numbering of objects











## 7.2 Supported Object Types

This section describes object types that may be present in the device. Lists of optional and proprietary properties are provided for each object type. Information on range restrictions and default values of properties can be found here too. Writable properties are marked in the “W” column.

### 7.2.1 Device

There is one instance of the *Device* object in the gateway. It represents the gateway itself.

Tab. 7.2 Device object – properties

Property Name	Value Range	Default	W
<b>Required</b>			
Object_Identifier		(device, 1001)	
Object_Name	1...126 bytes	EO-BAC_{Instance_Number}	 1)
Object_Type		device	
System_Status			
Vendor_Name			
Vendor_Identifier			
Model_Name			
Firmware_Revision			
Application_Software_Version			
Protocol_Version			
Protocol_Revision			
Protocol_Services_Supported			
Protocol_Object_Types_Supported			
Object_List			
Max_APDU_Length_Accepted			
Segmentation_Supported			
APDU_Timeout	0...65535 ms	6000 ms	
Number_Of_APDU_Retries	0...255	3	
Device_Address_Binding			
Database_Revision			
Property_List			
<b>Optional</b>			
Location	0...126 bytes	unknown	 1)
Description	0...126 bytes	Gateway EnOcean/BACnet-MSTP	 1)
Max_Master	0...127	127	
Max_Info_Frames	1...255	1	
<b>Proprietary</b>			
Offset_ID	0...4 194 175	1000	 2)
MSTP_Address	0...127	1	 2)
MSTP_Baudrate		38400 Bd	
LED_Indication		ENABLED	



1) After entering “!default”, the default text is restored.

2) Instance\_Number = Offset\_ID + MSTP\_Address, example: 1000 + 2 ⇒ (device, 1002)

### 7.2.2 Analog Input (AI)

The number of these objects depends on the number of assigned EnOcean devices and their type.

Tab. 7.3 Analog input object – properties

Property Name	Value Range	Default	W
<b>Required</b>			
Object_Identifier			
Object_Name		see below	
Object_Type			
Present_Value			 1)
Status_Flags			
Event_State			
Out_Of_Service		False	
Units			
Property_List			
<b>Optional</b>			
Description	0...126 bytes	see below	
Reliability			
Min_Pres_Value			
Max_Pres_Value			
COV_Increment	0...65535	65535 (Off)	 2)
<b>Proprietary</b>			

1) Present\_Value writable if Out\_Of\_Service = true.

2) Value 65535 turns off the COV reporting for the object.

**AI 100–4099:** Objects from this range are mapped to RX Values (see 7.1). AI 100–199 belongs to Channel 1, AI 200–299 to Channel 2, etc. Objects are not created for unused Values.



Object\_Name = “RX\_CH{ChNum}\_V{ValueIndex}\_{ValueName}”  
 (e.g. RX\_CH1\_V0\_Temperature)

Description = “{ValueName} {ValueRange}” (e.g. Temperature 0...40 °C)

### 7.2.3 Analog Output (AO)

The number of these objects depends on the number of assigned EnOcean devices and their type.

Tab. 7.4 Analog output object – properties

Property Name	Value Range	Default	W
<b>Required</b>			
Object_Identifier			
Object_Name		see below	
Object_Type			
Present_Value			
Status_Flags			
Event_State			
Out_Of_Service		False	

Units			
Priority_Array			
Relinquish_Default			
Property_List			
Current_Command_Priority			
<b>Optional</b>			
Description	0...126 bytes	see below	
Min_Pres_Value			
Max_Pres_Value			
<b>Proprietary</b>			

**AO 100100–104099:** Objects from this range are mapped to *TX Values* (see 7.1). AO 100100–100199 belongs to Channel 1, AI 100200–100299 to Channel 2, etc. Objects are not created for unused *Values*.



Object\_Name = “TX\_CH{ChNum}\_V{ValueIndex}\_{ValueName}”  
 (e.g. TX\_CH1\_V0\_Valve position)

Description = “{ValueName} {ValueRange}” (e.g. Valve position 0...100 %)

### 7.2.4 Multistate Value (MSV)

There are several MSV objects representing settings and states of the gateway and channels.





Tab. 7.5 Multistate value object – properties

Property Name	Value Range	Default	W
<b>Required</b>			
Object_Identifier			
Object_Name		see below	
Object_Type			
Present_Value			
Status_Flags			
Event_State			
Out_Of_Service		False	
Number_Of_States			
Property_List			
<b>Optional</b>			
Description	0...126 bytes	see below	 1)
State_Text			
<b>Proprietary</b>			

1) Writable only for Value Index 99 (MSV 199, 299, ..., 4099). After entering “!default”, the default text is restored.



Tab. 7.6 List of MSV objects

Ch.	Device	Object ID	Object Name	Description	W
-		MSV 1	UCOV_MODE	Broadcast mode for unsubscribed COV reporting	
		MSV 2	REPEATER_MODE	EnOcean repeater setting	
1...40	RX	MSV 199, 299, ..., 4099	CH{ChNum}_CONFIG	{EEP} {Title} ({SenderID})	
1...40	TX	MSV 100195, 100295, ..., 104095	TX_CH{ChNum}_SEND	Send option for Device{ChNum}	

**MSV 1–2:** These objects represent setting parameters of the gateway.

**MSV 1 (UCOV\_MODE):** This parameter configures the function of Unsubscribed Change of Value (UCOV) reporting for all AI objects that have COV reporting enabled (*COV\_Increment* < 65535). When turned on, the gateway sends a broadcast COV report (UnconfirmedCOVNotification message) if the condition specified by *COV\_Increment* property is met.

Value	Meaning
1 – OFF (default)	Turned off
2 – LOCAL	Turned on for local network reporting
3 – GLOBAL	Turned on for global network reporting

**MSV 2 (REPEATER\_MODE):** This parameter configures the function of EnOcean repeater. If turned on, the gateway forwards received telegrams in the EnOcean network.

Value	Meaning
1 – OFF (default)	Off
2 – LEVEL1	Level 1 (only original telegrams)
3 – LEVEL2	Level 2 (original and once repeated telegrams)

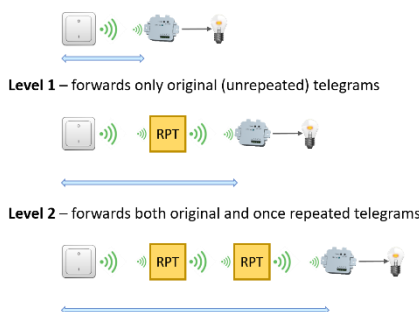

Fig. 7.5 Repeater function

**MSV 199, 299, ..., 4099 (CONFIG):** There are 40 MSV objects (one for each channel) that indicate the state of the channel.

Value	Meaning
1 – FREE (default)	The channel is not configured, no device is assigned.
2 – ASSIGNED	The channel is configured, a device is assigned.

**MSV 100195, 100295, ..., 104095 (SEND):** There are up to 40 of these objects (one for each channel), they are mapped to *TX Value 95*. It serves to control transmitting of data from the gateway to the device. Objects are created only for used channels.

Value	Meaning
1 – None (default)	Transmitting disabled
2 – SendNow	Transmit once immediately, the send option will not change
3 – OnReceived	Automatic response when telegram received from the assigned device (default for A5-20-01, etc.)
4...10	Reserved
11 – OnWriteV0	Transmit when Present_Value of AO 1xxx00 written
...	
25 – OnWriteV14	Transmit when Present_Value of AO 1xxx14 written
26 – OnWriteAny	Transmit when Present_Value of any AO 1xxx00...1xxx14 written

### 7.3 Proprietary properties

Tab. 7.7 Proprietary properties

Property Name	Property ID	Datatype	Value Range	Object Type	Meaning
Offset_ID	1000	Unsigned	0...4 194 175 (0x3F FF7F)	Device	Used to modify the Object_Identifier
MSTP_Address	1001	Unsigned	0...127	Device	MAC address of the gateway
MSTP_Baudrate	1002	Unsigned	1:9600 Bd 2:19200 3:38400 4:57600 5:76800 6:115200	Device	Communication speed of the MS/TP interface
LED_Indication	1100	Unsigned	0:DISABLED 1:ENABLED	Device	Allows to deactivate the LED indicators on the front panel

### 7.4 COV Notifications

The BACnet protocol allows clients to receive event notifications, e.g. when the value of an object has changed. The use of COV notifications reduces latency and network load. Regarding the EnOcean devices, a typical use case for COV is when we need to catch the button pressed events (F6-02-01, D2-03-0A, etc.).

There are several ways how to implement the COV reporting that differ in memory requirements, reliability and implementation complexity. The gateway currently supports Unsubscribed COV reporting (UCOV), which is the simplest type. It generates UnconfirmedCOVNotification messages without using COV subscriptions. These messages are addressed to all devices in the local network. This method of transferring information is called broadcasting, the broadcast MSTP address is used as the destination address (MstpBroadcastAddr = 255).

The COV reporting is configured by the **UCOV\_MODE** global setting and the **COV\_Increment** property of individual objects – see also Tab. 7.3 AND Tab. 7.6.

If UCOV\_MODE = OFF the UCOV is disabled regardless the COV\_Increment settings. If UCOV\_MODE = LOCAL the notifications are sent to all BACnet devices in the local network. If UCOV\_MODE = GLOBAL,

and there is a BACnet router in the local network, the notifications are forwarded to all available BACnet networks.

COV\_Increment enables reporting for the given object. The notification is sent when the absolute difference of the Present\_Value property is equal to or higher than the last reported value. For enumeration values, such as button press, the COV\_Increment should always be 1.

## 8 Firmware Update

The firmware is constantly being improved and extended to support new features and EnOcean devices. The actual version of the firmware is available for download on the FIRVENA website.

The number of firmware version can be determined using the *EO-BAC Tool*:

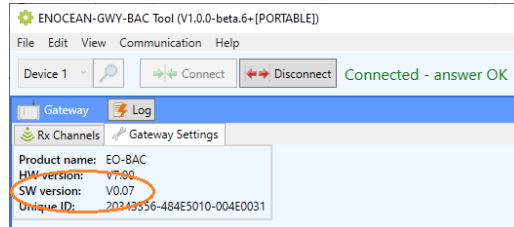

### To update firmware in the gateway:

- Unplug the RS485 connector
- Set the left switch to the “MSC” position
- Connect the gateway to a computer using a USB cable with type B connector
- The device appears as an external disk, copy a new firmware file to the disk

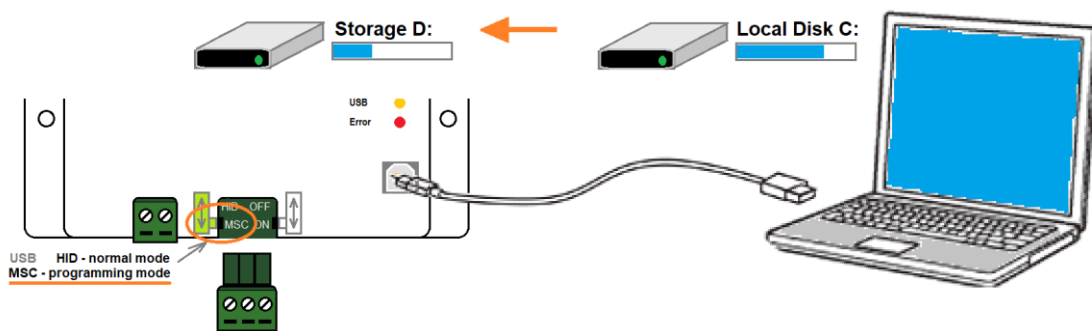

- Set the left switch back to the “HID” position, the gateway reboots
- Now, the gateway checks the file and overwrites the current firmware with the new one
- The result is indicated by LEDs
- Disconnect the USB cable and plug the RS485 connector back

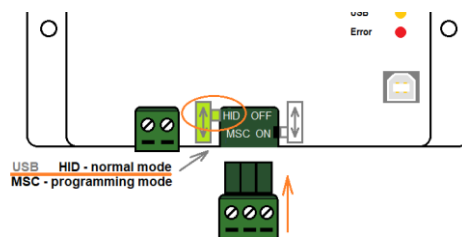

## References

- [1] EnOcean Technical Specifications (<https://www.enocean-alliance.org/specifications/>)
- [2] EnOcean Equipment Profiles (EEP) (<https://www.enocean-alliance.org/wp-content/uploads/2020/07/EnOcean-Equipment-Profiles-3-1.pdf>)
- [3] Communication telegrams defined in EnOcean equipment profiles (<http://tools.enocean-alliance.org/EEPViewer/>)
- [4] Smart Acknowledge – Bidirectional communication with energy harvesting devices ([https://www.enocean-alliance.org/wp-content/uploads/2020/04/SmartAcknowledge\\_Specification\\_v1.7.pdf](https://www.enocean-alliance.org/wp-content/uploads/2020/04/SmartAcknowledge_Specification_v1.7.pdf))
- [5] EnOcean Unique Radio Identifier – EURID Specification (<https://www.enocean-alliance.org/wp-content/uploads/2021/03/EURID-v1.2.pdf>)
- [6] Yabe (BACnet Explorer) (<https://sourceforge.net/projects/yetanotherbacnetexplorer/>)



## Revision History

Date	Version	Description
2022-04-01	V1.0	Initial release
2022-08-05	V1.1	Added bidirectional communication
2022-11-01	V1.2	Added Ch. 6.1.5 Updated figures Updated ANNEX A
2022-12-14	V1.3	Chapters rearranged Added Ch 4, 5
2022-01-23	V1.4	Extended ANNEX A (D2-01-XX)
2023-03-24	V1.5	Added description of LED functions (Ch. 2) Added description of COV notifications (Ch. 7.4)



## ANNEX A Mapping examples of EnOcean devices

### A.1 Basic Examples

#### MSV 199, 299, ..., 4099:

Ch.	Device	Object ID	Object Name	Description	Value
1		MSV 199	CH1_CONFIG	A5-02-05 Temperature Sensors, Temperature Sensor Range 0°C to +40°C (01-81-28-68)	ASSIGNED
2		MSV 299	CH2_CONFIG	00-00-00 None (FF-FF-FF-FF)	FREE
...					
32		MSV 3299	CH32_CONFIG	D5-00-01 Contacts and Switches, Single Input Contact (01-C1-2E-70)	ASSIGNED
...					
39		MSV 3999	CH39_CONFIG	00-00-00 None (FF-FF-FF-FF)	FREE
40		MSV 4099	CH40_CONFIG	A5-09-04 CO2 Sensor (01-85-BA-3E)	ASSIGNED

**AI 100–4099:**

Ch.	Device	Object ID	Object Name	Description	Present Value	Unit
1	A5-02-05 	AI 100	CH1_V0_Temperature	Temperature 0...40 °C	22.4	°C
		AI 190	CH1_V90_Telegram counter	Number of received telegrams 0...65535	12	–
		AI 191	CH1_V91_Telegram age	Time elapsed since the last telegram 0...65000 s	252	s
2	00-00-00					
...						
32	D5-00-01 	AI 3200	CH32_V0_Contact	Contact 0:open, 1:closed	1	–
		AI 3290	CH32_V90_Telegram counter	Number of received telegrams 0...65535	50	–
		AI 3291	CH32_V91_Telegram age	Time elapsed since the last telegram 0...65000 s	10	s
39	00-00-00					
40	A5-09-04 	AI 4000	CH40_0_Humidity	Humidity 0...100 %	45	%
		AI 4001	CH40_1_Concentration	Concentration 0...2550 ppm	1451	ppm
		AI 4002	CH40_2_Temperature	Temperature 0...51 °C	23.2	°C
		AI 4090	CH40_V90_Telegram counter	Number of received telegrams 0...65535	2	–
		AI 4091	CH40_V91_Telegram age	Time elapsed since the last telegram 0...65000 s	33	s



## A.2 RPS Buttons and Switches

The following example applies to F6-02-01, F6-02-02, F6-02-03 and F6-02-04

Ch.	Device	Object ID	Object Name	Description	Present Value	Unit
1	 F6-02-02	AI 100	CH1_V0_BI	BI 0:released, 1:pressed	1	–
		AI 101	CH1_V1_B0	B0 0:released, 1:pressed	0	–
		AI 102	CH1_V2_AI	AI 0:released, 1:pressed	0	–
		AI 103	CH1_V3_A0	A0 0:released, 1:pressed	0	–
		AI 104	CH1_V4_Rocker B	-1:null, 0:off, 1:on	1	–
		AI 105	CH1_V4_Rocker A	-1:null, 0:off, 1:on	0	–
		AI 190	CH1_V90_Telegram counter	Number of received telegrams 0...65535	12	–
		AI 191	CH1_V91_Telegram age	Time elapsed since the last telegram 0...65000 s	1	s
2	00-00-00					
...						

V4 and V5 remember the rocker state for channel A and B, this is out of the EEP definition. Rocker B goes 1:on when BI was pressed, Rocker B goes 0:off when B0 was pressed. When no telegram has been received yet, rocker has the initial value -1:null.

## A.3 A5-20-01 HVAC Components, Battery Powered Actuator

The actuator wakes up periodically, transmits the actual value and waits for a response with a new setpoint, which must be sent within 1 second. The response is built from Present\_Value properties of TX data objects. The response also contains other settings, e.g. Set point type selection, Set point inverse, Summer mode, Service mode. Not all objects are listed in the table, max. number of data values is 10.

**Direction RX (from actuator):**

Ch.	Device	Object ID	Object Name	Description	Present Value	Unit		
1	 A5-20-01	AI 100	RX_CH1_V0_Current Value	Current Value 0...100 %	25	%		
		...	Values according to the EEP spec. and visibility setting					
		AI 109						
		AI 190	RX_CH1_V90_Telegram counter	Number of received telegrams 0...65535	155	–		
		AI 191	RX_CH1_V91_Telegram age	Time elapsed since the last telegram 0...65000 s	231	s		
		MSV 199	CH1_CONFIG	A5-20-01 HVAC Components, Battery Powered Actuator (01-89-6C-98)	2	–		
		2	00-00-00					
...								

**Direction TX (to actuator):**

Ch.	Device	Object ID	Object Name	Description	Present Value	Unit	
1	A5-20-01	AO 100100	TX_CH1_V0_Valve position or Temperature Setpoint	Valve position or Temperature Setpoint 0...100 %	25	%	
		...	Values according to the EEP spec. and visibility setting				
		AO 100109					
		MSV 100195	TX_CH1_SEND	Send option for Device1	3 (OnReceive)	-	
2	00-00-00						
...							

**A.4 D2-01-XX Electronic switches and dimmers with Energy Measurement and Local Control**

Device types from the D2-01-XX group share the same telegram definitions – see the profile D2-01-00 (<http://tools.enOcean-alliance.org/EEPViewer/profiles/D2/01/00/D2-01-00.pdf>). There are several messages distinguished by the Command ID data field. Each type supports only certain commands and functions, e.g. type 0x02 has one dimmable output, type 0x12 has two relay outputs without dimming function or type 0x0B supports energy and power measurements.

The gateway creates a universal interface for all device types from the D2-01-XX group, regardless of the features supported by a particular type.

**A.4.1 Example with NodOn Micro Smart Plug (D2-01-0E) – Measurements**

This actuator has one output channel and supports energy and power measurements.

**Incoming data**

Objects AI101...106 contains data from the status message CMD 4, objects 107...110 from the measurement message CMD 7. The object AI100 indicates which CMD was received last.

Object ID	Value Name	Range	Value	Visible
AI 100	Command ID	4:Status Response;7...	4:Status Response	<input checked="" type="checkbox"/>
AI 101	I/O channel (STATUS)	0...31	0	<input checked="" type="checkbox"/>
AI 102	Output value	0...127 %	0%	<input checked="" type="checkbox"/>
AI 103	Power Failure	0:Disabled / not supp...	0:Disabled / not supported	<input checked="" type="checkbox"/>
AI 104	Over current switch off	0:Ready / not suppor...	0:Ready / not supported	<input checked="" type="checkbox"/>
AI 105	Error level	0:Hardware OK;1:Ha...	3:Not supported	<input checked="" type="checkbox"/>
AI 106	Local control	0:Disabled / not supp...	1:Enabled	<input checked="" type="checkbox"/>
AI 107	I/O channel (MEASUREMENT)	0...31	0	<input checked="" type="checkbox"/>
AI 108	Unit	0:Energy [Ws];1:Ener...	0:Energy [Ws]	<input checked="" type="checkbox"/>
AI 109	Measurement value (MSB)	0...65535	0	<input checked="" type="checkbox"/>
AI 110	Measurement value (LSB)	0...65535	0	<input checked="" type="checkbox"/>
AI 190	Telegram counter	0...65535	0	<input checked="" type="checkbox"/>
AI 191	Telegram age	0...65000 s	65535s	<input checked="" type="checkbox"/>

**CMD4 – status**

**CMD7 – measurement**

The most important is *CMD4* -> *Output value*, which indicates the ON/OFF state of the actuator.

**Outgoing data**

It is possible to transmit different commands. A constant number of objects is created, the number is given by the message utilizing the maximum number of objects. The command is switched by the

*Command ID* value, which is always at the first position (AO100100). The meaning of the objects from AO100101 up depends on the *Command ID*. The default command is CMD1.

AO 100100	Command ID	1:Set Output;2:Set L...	1:Set Output	<input checked="" type="checkbox"/>
AO 100101	I/O channel	0..31	0	<input checked="" type="checkbox"/>
AO 100102	Output value	0..127 %	0 %	<input checked="" type="checkbox"/>
AO 100103	Dim value	0:Switch to output val...	0:Switch to output value	<input checked="" type="checkbox"/>
AO 100104	None	0..0	0	<input checked="" type="checkbox"/>
AO 100105	None	0..0	0	<input checked="" type="checkbox"/>
AO 100106	None	0..0	0	<input checked="" type="checkbox"/>
AO 100107	None	0..0	0	<input checked="" type="checkbox"/>
AO 100108	None	0..0	0	<input checked="" type="checkbox"/>
AO 100109	None	0..0	0	<input checked="" type="checkbox"/>
AO 100110	None	0..0	0	<input checked="" type="checkbox"/>
AO 100111	None	0..0	0	<input checked="" type="checkbox"/>
	Telegram counter	0..65535	0	
	Telegram age	0..65000 s	65535s	
MSV 100195	SEND	1:None;2:SendNow;3...	1:None	
MSV 199	CONFIG	1:FREE;2:ASSIGNED	2:ASSIGNED	

CMD1 – set output

The most important is CMD 1, which is used to switch ON/OFF the output (0% => OFF; 100% => ON). The *Output value in percent* and *Dim value* is only applicable to devices with the dimming feature supported. The value 127% corresponds to 0x7F: *Output value not valid / not applicable*.

### Setting up the measurement through BACnet interface

1. Set Command ID (AO100100) to CMD 5 – Set Measurement
2. The meaning of objects is as follows:

AO 101000	Command ID	1:Set Output;2:Set L...	5:Set Measurement	<input checked="" type="checkbox"/>
AO 101001	I/O channel	0..31	0	<input checked="" type="checkbox"/>
AO 101002	Report measurement	0:Query only;1:Query...	0:Query only	<input checked="" type="checkbox"/>
AO 101003	Reset measurement	0:False;1:True	0:False	<input checked="" type="checkbox"/>
AO 101004	Measurement mode	0:Energy;1:Power	0:Energy	<input checked="" type="checkbox"/>
AO 101005	Unit	0:Energy [Ws];1:Ener...	2:Energy [KWh]	<input checked="" type="checkbox"/>
AO 101006	Delta to be reported (MSB)	0..4095	0	<input checked="" type="checkbox"/>
AO 101007	Delta to be reported (LSB)	0..4095	0	<input checked="" type="checkbox"/>
AO 101008	Max time between messages	1..2550 s	255 s	<input checked="" type="checkbox"/>
AO 101009	Min time between messages	1..255 s	10 s	<input checked="" type="checkbox"/>
AO 101010	None	0..0	0	<input checked="" type="checkbox"/>
AO 101011	None	0..0	0	<input checked="" type="checkbox"/>
	Telegram counter	0..65535	4	
	Telegram age	0..65000 s	136s	
MSV 101095	SEND	1:None;2:SendNow;3...	1:None	
MSV 1099	CONFIG	1:FREE;2:ASSIGNED	2:ASSIGNED	

CMD5 – set measurement

3. Enter inputs, there are several parameters according to the EEP specification.
4. Write SEND = 2:SendNow to transmit the telegram to the actuator.

The type D2-01-0E supports measurement report on query (CMD 6) or automatic reporting based on the configuration sent in the CMD 5.

The power and energy measurements are configured and reported separately, determined by CMD 5 -> *Measurement mode* and *Unit*; CMD 4 -> *Unit*.

The measured value is 4 byte in size, split into two 16-bit values (Measurement value = 256 \* MSB + LSB), the physical unit is indicated by the *Unit* value.

## A.4.2 Example with NodOn Relay Switch (D2-01-12) – Controlling the output

This actuator has two output channels, the example shows switching ON of the second channel. TX data are first prepared by writing into the TX data objects, then the control telegram (CMD1 – Set output) is sent by writing *Send option = 2:SendNow*. The actuator returns a status message (CMD4 – Status response), the message says the channel 2 (numbered from zero) is ON.

The *Send option* can also be configured so that the gateway sends when *Output value* is written (*Send option = 13:OnWriteV2*).

*Dim value* is not supported by this type and is ignored.

### Direction TX (to actuator):

Ch.	Device	Object ID	Object Name	Description	Present Value	Unit
1	D2-01-12	AO 100100	TX_CH1_V0_Command ID	1:Set Output;2:Set Local; ...	1	–
		AO 100101	TX_CH1_V1_I/O channel	0...31	1	–
		AO 100102	TX_CH1_V2_Output value	0...127 %	100	%
		AO 100103	TX_CH1_V3_Dim value	0:Switch to output value;1:Dim to output value – timer 1; ...	0	–
		MSV 100195	TX_CH1_SEND	Send option for Device1	2 (SendNow)	–
2	00-00-00					
...						

### Direction RX (from actuator):

Ch.	Device	Object ID	Object Name	Description	Present Value	Unit	
1	 D2-01-12	AI 100	RX_CH1_V0_Command ID	4:Status Response; 7:Measurement Response;	4	–	
		AI 101	RX_CH1_V1_I/O channel	0...31	1	–	
		AI 102	RX_CH1_V2_Output value	0...127 %	100	%	
		...	Other objects				
		AI 190	RX_CH1_V90_Telegram counter	Number of received telegrams 0...65535	45	–	
		AI 191	RX_CH1_V91_Telegram age	Time elapsed since the last telegram 0...65000 s	4563	s	
		MSV 199	CH1_CONFIG	D2-01-12 Electronic switches and dimmers with Energy Measurement and Local Control, Type 0x12 (05-84-2C-D0)	2	–	
2	00-00-00						
...							

## A.5 D2-11-XX Bidirectional Room Operating Panel (Smart ACK)

### What is Smart ACK?

EnOcean sensors are in sleep mode most of the time to reduce power consumption, so they cannot receive any telegram. The Smart ACK protocol enables bidirectional communication with energy self-sufficient devices. For example, Room Operating Panels D2-11-XX utilize the Smart ACK communication to receive data, which is used to show symbols on the display or override some parameters.

The Smart ACK protocol is described in [4]. When a message is sent to a Smart ACK Sensor, a device called “Post Master” stores it in a “Mailbox” until the sensor is ready to receive telegrams. When the sensor wakes up, it checks the Mailbox. The Post Master sends the message buffered in the Mailbox or Mailbox Empty message if the Mailbox is empty. The sensor receives the response from Post Master and returns to sleep mode. The Mailbox is established in Post Master during teach-in process.

The gateway does not support repeaters, there must be a direct connection between the gateway and the Smart ACK device, i.e. Post Master and Mailbox are located in the gateway.

### A.5.1 Example with Thermokon SR06 LCD (D2-11-07)

#### Direction RX (from sensor):

The sensor sends two types of messages, ID 0 or ID 2. When Message ID is 0, only Set Point Type is valid, other values should be ignored.

Communication is initiated by the sensor on heartbeat (default 1000 s), change of measured value or button press (parameter change), which is indicated by TelegramType.

Ch.	Device	Object ID	Object Name	Description	Present Value	Unit
1	 D2-11-07	AI 100	Set Setpoint type	0:Temperature correction;1:Temperature setpoint	1	–
		AI 101	Telegram Type	0:Heartbeat;1:Change of temperature or humidity value;2:User caused parameter change	2	–
		AI 102	Message ID	0:ID-0;2:ID-2	2	–
		AI 103	Temperature	0...40 °C	23.84	°C
		AI 104	Humidity	0...100 %	0	%
		AI 105	Setpoint offset	0...255	170	–
		AI 106	Basetpoint	15...30 °C	21	°C
		AI 107	Valid temperature correction	1:-1...1K;2:-2...2K;3:-3...3K;4:-4...4K;5:-5...5K;6:-6...6K;7:-7...7K;8:-8...8K;9:-9...9K;10:-10...10K	3	–
		AI 108	Fan speed	0:Auto;1:Speed 0;2:Speed 1;3:Speed 2;4:Speed 3;7:Not available	7	–
		AI 109	Occupancy state	0:State Unoccupied;1:State Occupied	0	–
...						
2	00-00-00					

...						
-----	--	--	--	--	--	--

**Direction TX (to sensor):**

The gateway responds with message ID 1. Settings are changed by writing these values and SendOption = 2:SendNow, changes will apply next time the sensor wakes up. Without a response, the sensor uses the last settings.

SetPointType, TemperatureCorrection, BaseSetpoint and ValidTemperatureCorrection must be mirrored from RX data if no change is required.

Ch.	Device	Object ID	Object Name	Description	Present Value	Unit
1	D2-11-07	AO 100100	Set Setpoint type	0:Temperature correction;1:Temperature setpoint	1	-
		AO 100101	Display heating symbol	0:Heating symbol off;1:Heating symbol on	0	-
		AO 100102	Display cooling symbol	0:Cooling symbol off;1:Cooling symbol on	0	-
		AO 100103	Display window open symbol	0:Window open symbol off;1:Window open symbol on	1	-
		AO 100104	Message ID	1:ID-1	1	-
		AO 100105	Temperature correction	0...255	128	-
		AO 100106	Basetpoint	15...30 °C	21	°C
		AO 100107	Valid temperature correction	1:-1...1K;2:-2...2K;3:-3...3K;4:-4...4K;5:-5...5K;6:-6...6K;7:-7...7K;8:-8...8K;9:-9...9K;10:-10...10K	3	-
		AO 100108	Fan speed	0:Auto;1:Speed 0;2:Speed 1;3:Speed 2;4:Speed 3;7:Not available	0	-
		AO 100109	Occupancy state	0:State Unoccupied;1:State Occupied	0	-
		MSV 100195	TX_CH1_SEND	Send option for Device10	2 (SendNow)	-
2	00-00-00					
...						

## A.6 D2-15-00 People Activity Sensor

Ch.	Device	Object ID	Object Name	Description	Present Value	Unit	
1	D2-15-00 	AI 100	CH1_V0_Presence	0:Present;1:Not Present;2:Not detectable;3:Presence Detector error	0	–	
		AI 101	CH1_V1_Energy Storage Status	0:High;1:Medium;2:Low;3:Critical	0	–	
		AI 102	CH1_V2_Pir Update Rate	1...16 s	1	s	
		AI 103	CH1_V3_Pir Counter	0...65535	7568	–	
		AI 104	CH1_V4_Activity	0...100 %	52	%	
		AI 190	CH1_V90_Telegram counter	Number of received telegrams 0...65535	6	–	
		AI 191	CH1_V91_Telegram age	Time elapsed since the last telegram 0...65000 s	11	s	
	MSV 199	CH1_CONFIG	D2-15-00 People Activity Sensor (00-31-C2-2F)	2	–		
2	00-00-00						
...							

The Activity is computed by gateway based on two subsequent values of the Pir Counter. When the Pir Update Rate is 1s and the sensor transmits data every 2 minutes, 100% corresponds to the Pir Counter increment of 120.

$$Activity[\%] = \frac{(PIRCounterCurrent - PIRCounterLast) \cdot PIRUpdateRate[s]}{TelegramAgeLast[s] - TelegramAgeCurrent[s]}$$

## ANNEX B BACnet Protocol Implementation Conformance Statement (PICS)

**Date:** March 28, 2022  
**Vendor Name:** FIRVENA s.r.o.  
**Product Name:** EO-BAC  
**Product Model Number:** EO-BAC  
**Application Software Version:** V1.0  
**Firmware Revision:** V1.0  
**BACnet Protocol Revision:** 14

### Product Description:

The EO-BAC device is a gateway between EnOcean and BACnet MS/TP communication protocols. It receives data from EnOcean sensors and provides it to other devices connected to the BACnet network.

### BACnet Standardized Device Profiles Supported:

BACnet Gateway (B-GW)

### BACnet Interoperability Building Blocks Supported:

Data Sharing-ReadProperty-B (DS-RP-B)  
Data Sharing-ReadPropertyMultiple-B (DS-RPM-B)  
Data Sharing-WriteProperty-B (DS-WP-B)  
Data Sharing-WritePropertyMultiple-B (DS-WPM-B)  
Data Sharing-Change Of Value Unsubscribed-B (DS-COVU-B)  
Device Management-Dynamic Device Binding-B (DM-DDB-B)  
Device Management-Dynamic Object Binding-B (DM-DOB-B)  
Device Management-DeviceCommunicationControl-B (DM-DCC-B)  
Gateway-Embedded Objects-B (GW-EO-B)

**Segmentation Capability:** No segmentation

### Standard Object Types Supported:

Refer to user manual

**BACnet Data Link Layer Options:** MS/TP master  
Baud rates: 9600, 19200, 38400, 57600, 76800, 115200 Bd

**Device Address Binding:** No

**Networking Options:** None

**Character Sets Supported:** ISO 10646 (UTF-8)

### Gateway Options:

Refer to user manual